

VERTEDERO 24-SD-TM

V 22-04

VISTAS

MODELO VER-24-SOLDADO-TALADROS CON MÉNSULAS

CLAVE VER-24-SD-TM

MATERIAL

- ACERO INOXIDABLE
- TIPO 304
- GRADO SANITARIO
- TERMINADO P3
- CALIBRE: 20 (0.89MM)

MEDIDAS

- LONGITUD 41
- FONDO 48
- ALTURA 24

CARACTERÍSTICAS

- FABRICADO EN ACERO INOXIDABLE TIPO 304.

*COTAS EN CM



FRONTAL

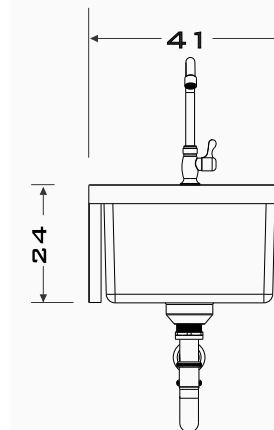

SUPERIOR

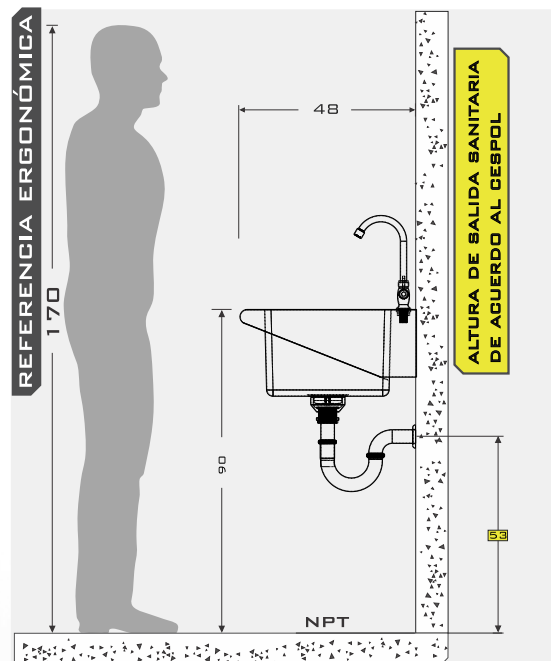
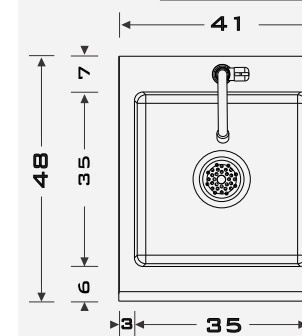

FIJACIÓN

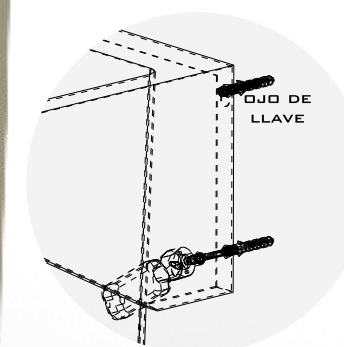

DETALLE 1

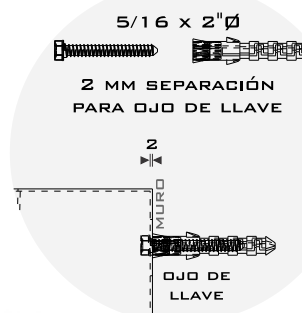

POSTERIOR

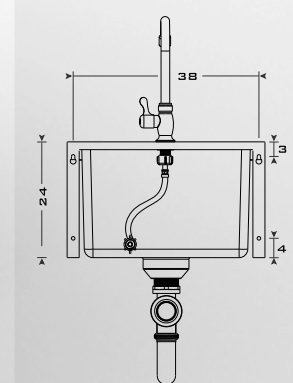

DETALLE 2

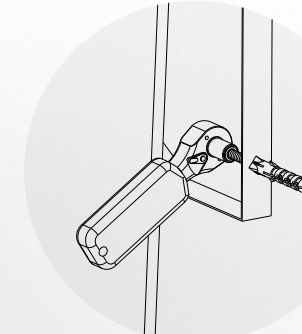

- (55) 4992 9517
- (55) 5852 0068
- info@aminox.com.mx

NO INCLUYE

- TORNILLOS, U OTRO MEDIO DE ANCLAJE
- VÁLVULAS O LLAVES
- CONTRACANASTA
- CESPOL, COFLEX O CONEXIONES
- INSTALACIÓN
- MANTENIMIENTO

